

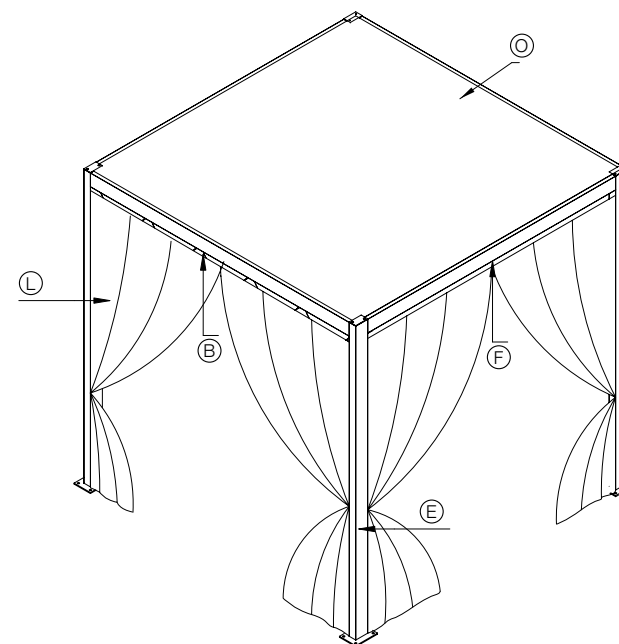



9010



 Struttura ombreggiante in alluminio la cui copertura può essere realizzata con telo superiore in tessuto Soltis 86 e/o con tenda a scorrimento manuale caratterizzata dalla conformazione ad onda (S Light). Su richiesta è possibile prevedere anche l'installazione di tende perimetrali. Struttura dedicata alla protezione solare, non è garantita la tenuta all'acqua ed alla neve.

 Covering Shading structure in aluminum can be made with top fabric Soltis 86 and / or with manual sliding awning characterized by waving shape (S Light). On request, we can also provide the installation of drop awning. The resistance under snow and water are not guaranteed.

 Bei der schattenspendende Aluminiumstruktur kann das obere Tuch in Soltis 86 und/oder mit durchhängendem Tuch und Handbetrieb hergestellt werden (S Light). Auf Anfrage können auch Fallmarkisen installiert werden. Die Struktur ist zum Sonnenschutz und nicht zum Schutz vor Regen oder Schnee vorgesehen.

 La structure d'ombrage en aluminium dans laquelle la couverture peut être faite avec en tissu Soltis 86 et / ou store coulissant manuel caractérisé par empaiement à vagues (S Light). Sur demande, nous pouvons également fournir l'installation de stores périmètres. Etant une Structure dédiée à la protection solaire n'est pas garanti étanche à la neige et à la pluie.

 Estructura sombreante en aluminio con lona superior en tejido Soltis 86 y/o con toldo a escurrimiento manual caracterizada para su forma ondulada (S Light). A petición se pueden instalar también toldas perimetricas. Estructura dedicada a la protección solar, no esta garantizada la resistencia a agua y nieve.

B S Light
O Telo superiore in Soltis 86
F Trave perimetrale
E Pilaastro
L Tende perimetrali

B S Light
O Upper Fabric in Soltis 86
F Edge beam
E Pillar
L Drop awning

B S Light
O Oberes Tuch in Soltis 86
F Seitlicher Träger
E Säule
L Fallmarkisen

B S Light
O Toile Soltis 86
F Poutre périphérique
E Pilier
L Stores verticaux

B S Light
O Lona superior en Soltis 86
F Perfil perimetrico
E Columna
L Toldas perimetricas



Schema tecnico generale - General technical plan - Allgemein technisches Schema - Plan technique général - Dibujo tecnico general

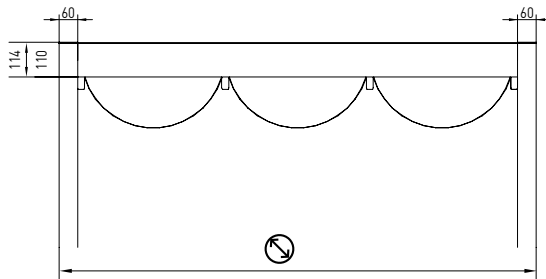

Larghezza interasse colonne - Column interaxis width - Breite des Achsabstandes der Führungsschienen - Largeur entraxe colonne - Linea columna intereje

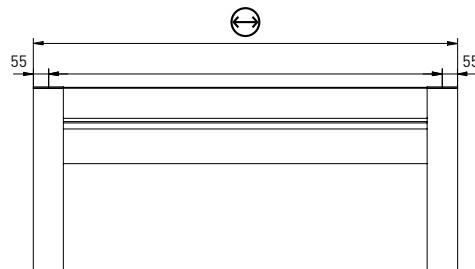

Dimensioni profili - Profiles dimensions - Profilabmessungen
Mesures profils - Dimensiones perfiles

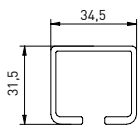

Guida (S Light)
Guide (S Light)
Führungsschiene (S Light)
Glissière (S Light)
Guía (S Light)

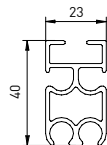

**Traverso
Porta Tessuto (S Light)**
Fabric carrying Crossbar profile (S Light)
Stoffquerträger (S Light)
Profil de traverse Porte tissu (S Light)
Patillo (S Light)



Sezione travi - Girder section - Balkenquerschnitt
Section poutres - Sección viga

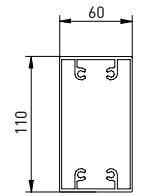

Trave perimetrale
Edge beam
Seitlicher Träger
Poutre périphérique
Perfil perimetrico

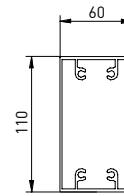

Pilastro
Pilar
Profil
Pilier
Columna



Attacchi a terra SAKI (Standard) - Saki ground connection (Standard)
Saki Bodenbefestigung (Standard) - Support fixation sol Saki (Standard)
Sujección a suelo Saki (Standard)

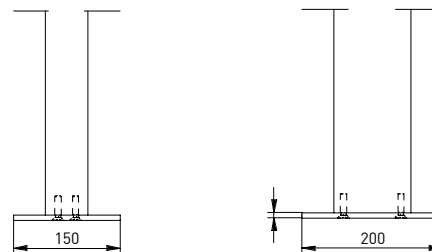
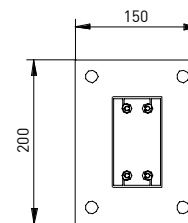

Piastra attacco su sabbia (Optional) - Connection plate sand (Optional)
Montageplatte für Sand (Optional) - Plaque de connexion sur le sable (Option)
Plancha por enganche en arena (Opcional)

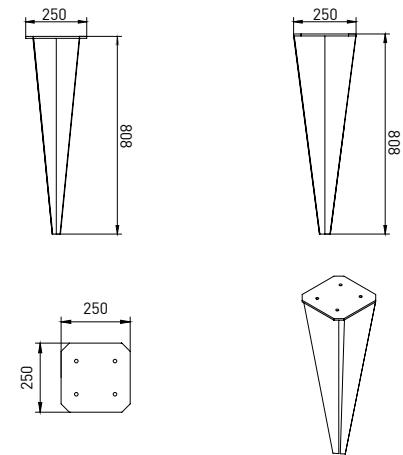

Piastra attacco su terreno (Optional) - Connection plate ground (Optional)
Bodenmontageplatte (Optional) - Plaque de connexion sur le terrain (Option)
Plancha por enganche en terreno (Opcional)

